

New WM wall mounted cabinet fan hole increase ventilation rate

Ventilation rate
72%

Ventilation rate
49%

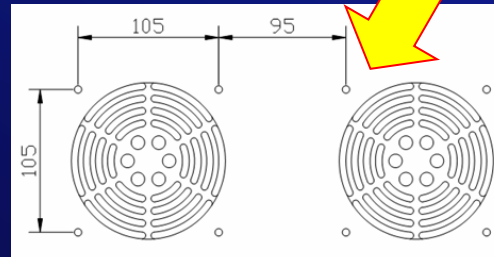
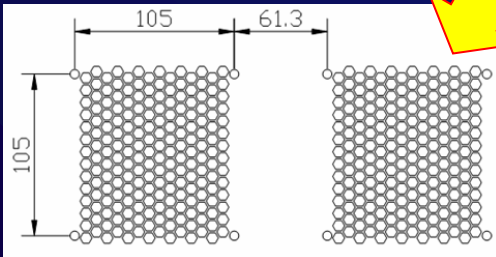
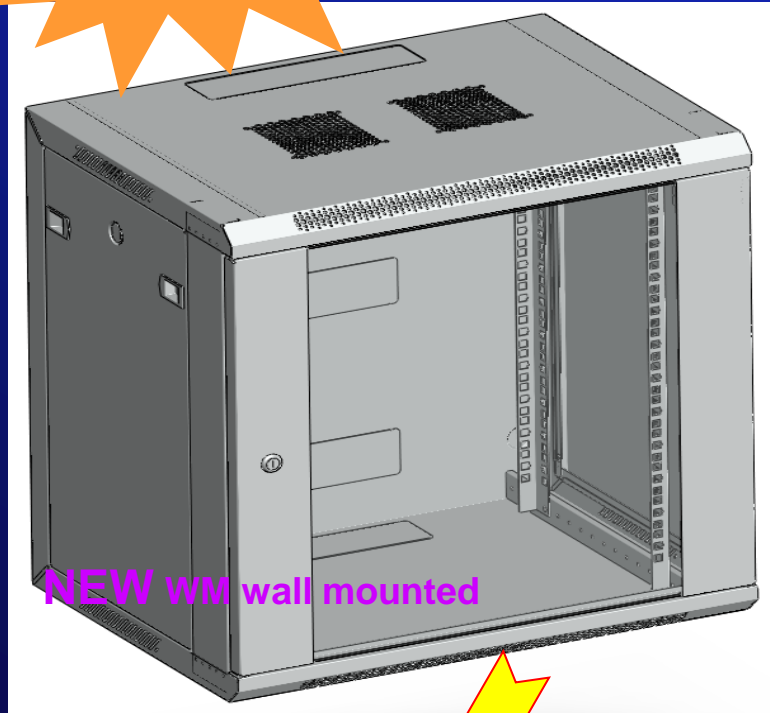

New WM wall mounted cabinet can realize the standing installation (option)

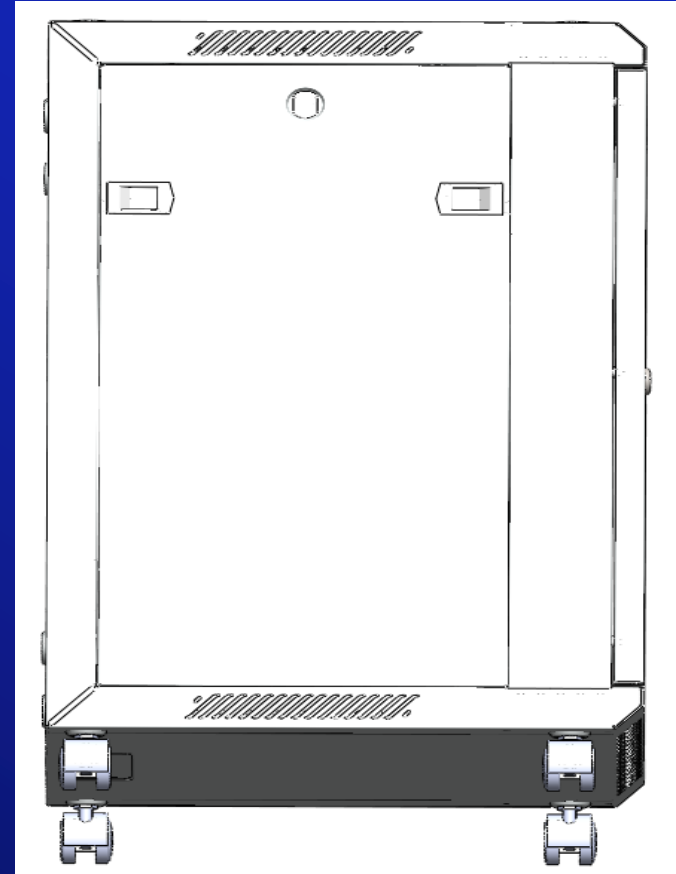
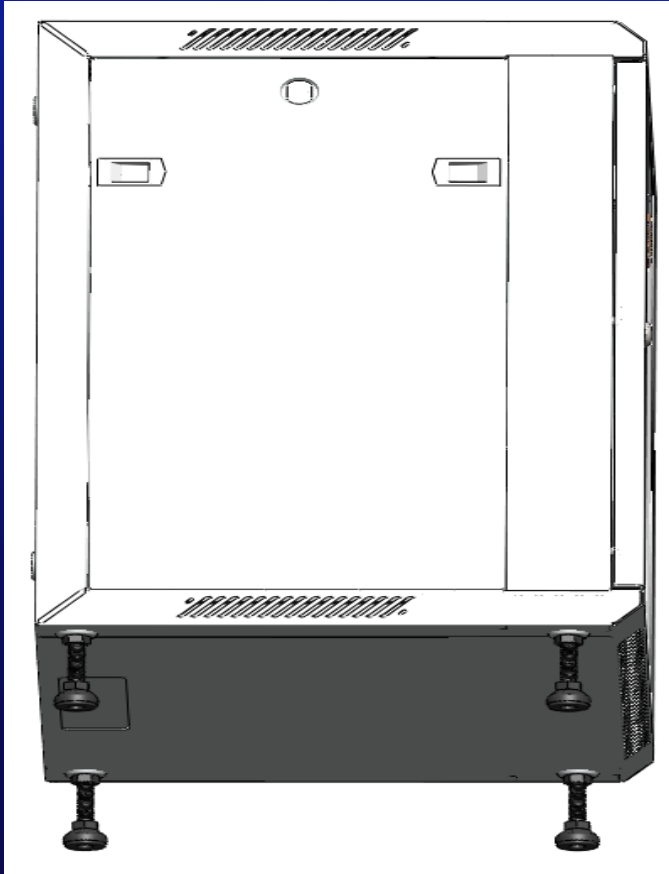

New WM wall mounted cabinet can realize the standing installation, customer can buy the castors and adjustable feet at your option to realize the flooring installation

New wall mounted cabinet can improve the efficiency of installation of mounting profiles

Use the self-tapping screws to install the mounting profiles



Use the square screws and nut to install the mounting profiles



We use the self tapping screws to install the mounting-profiles ,which can save the time of installing the square nuts and reduce the long-shape tools .

The working efficiency is increased prominently

New wall mounted cabinet can better the equipment installation accuracy

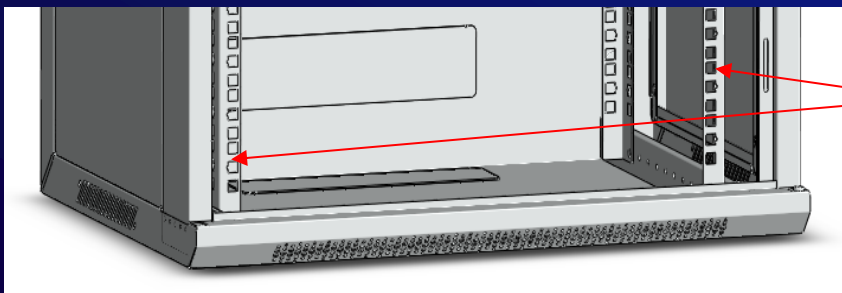
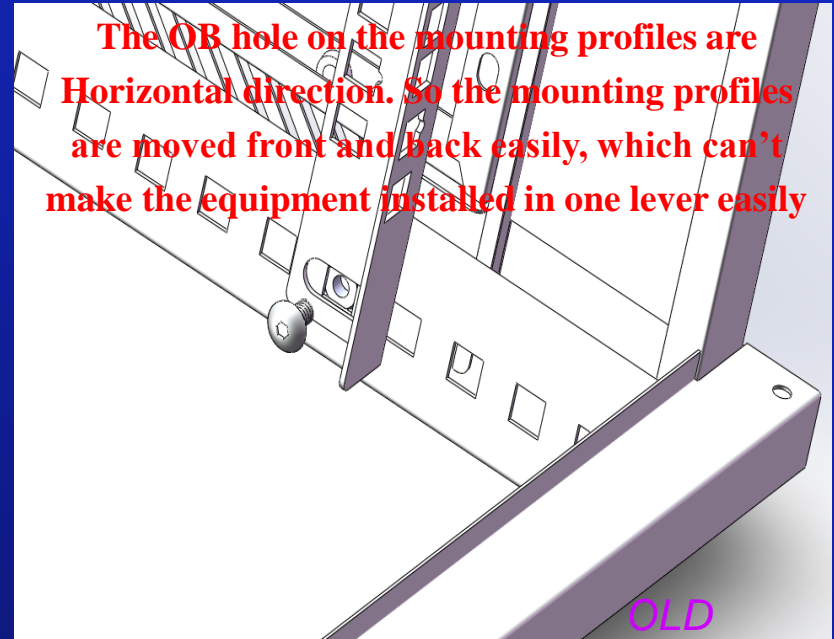
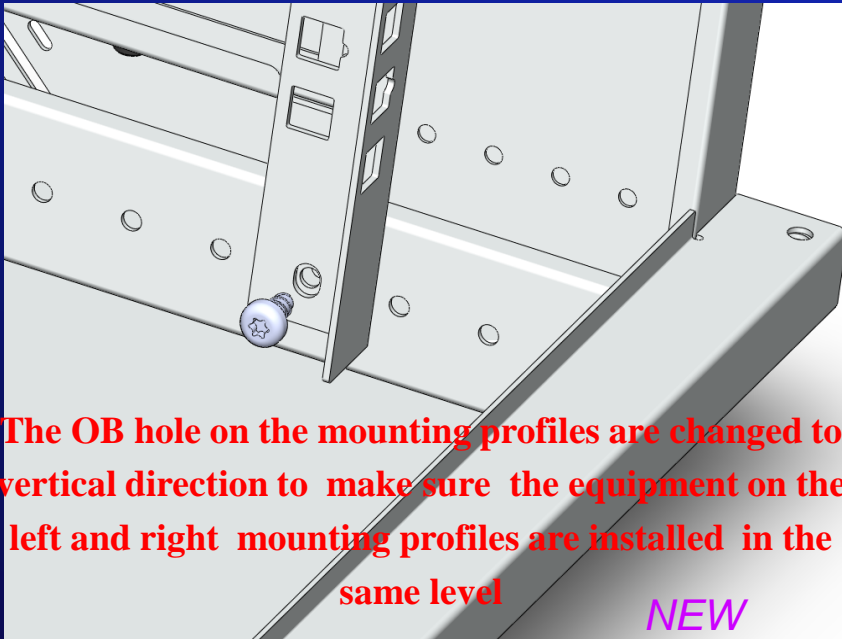

Increase the cable entrance hole on the back

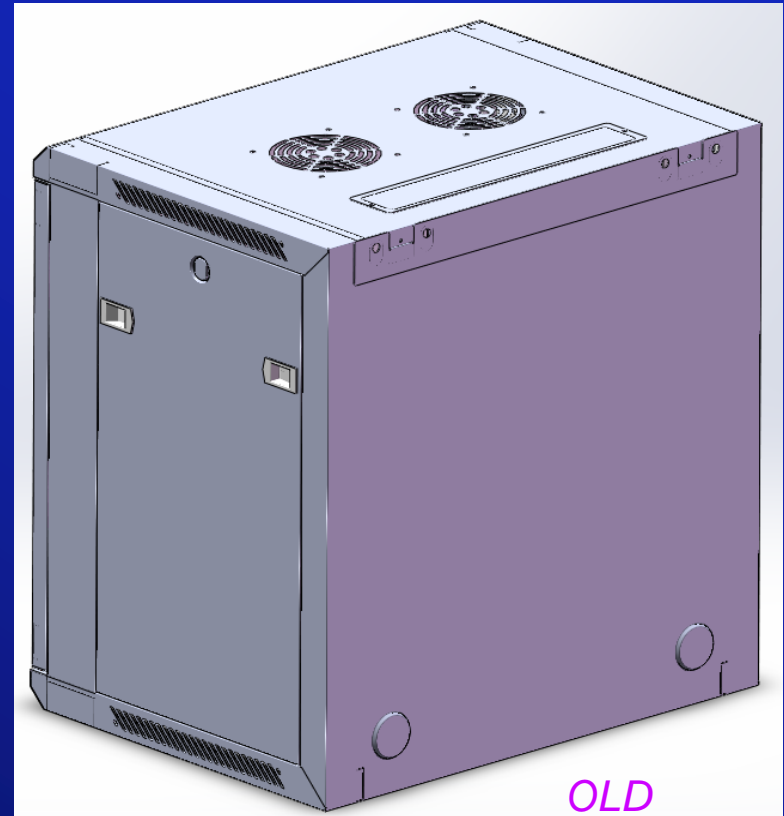
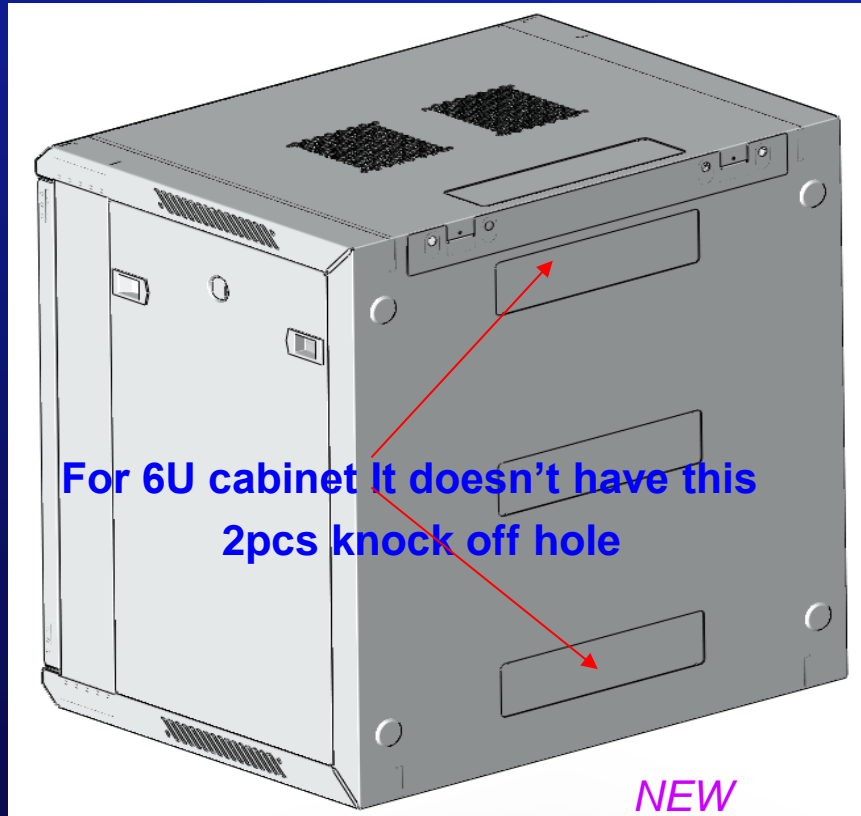

Increase 3 pcs of Knock-off hole on the back .Each hole can install 300pcs cable .

For new Wm wall mounted cabinet ,The distance between the back panel and entrance hole on the top cover and bottom panel is reduced

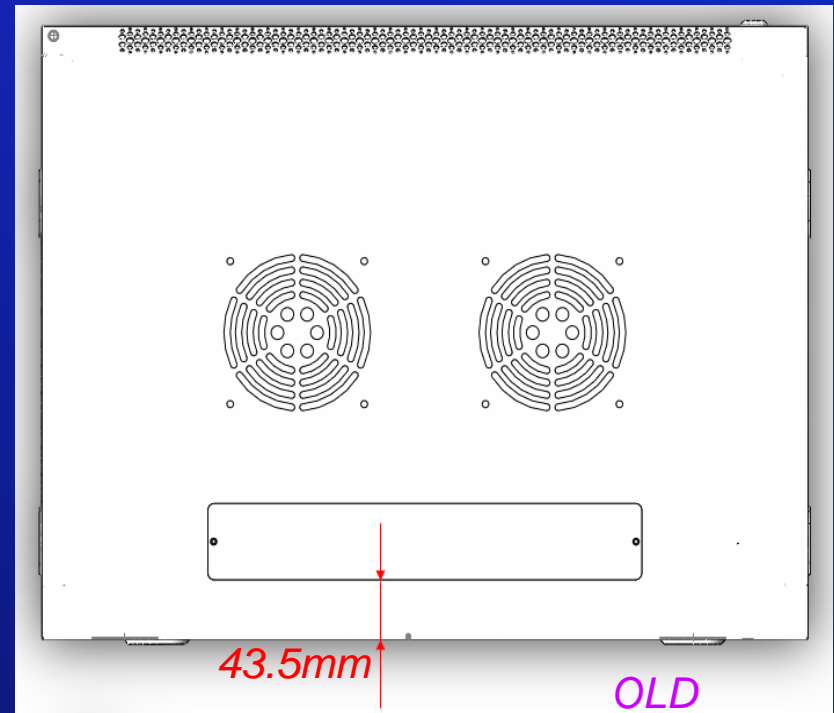
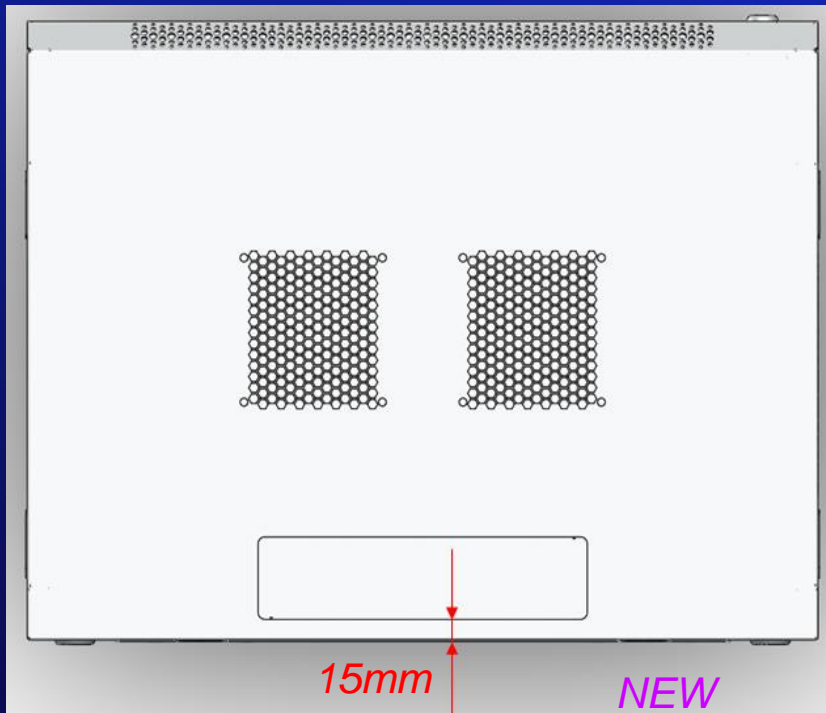

The distance between the back panel and entrance hole on the top cover and bottom panel is reduced, which can ease the bending of cable entrance from the top and bottom .

The distance between the assembling hole on the back panels are changed

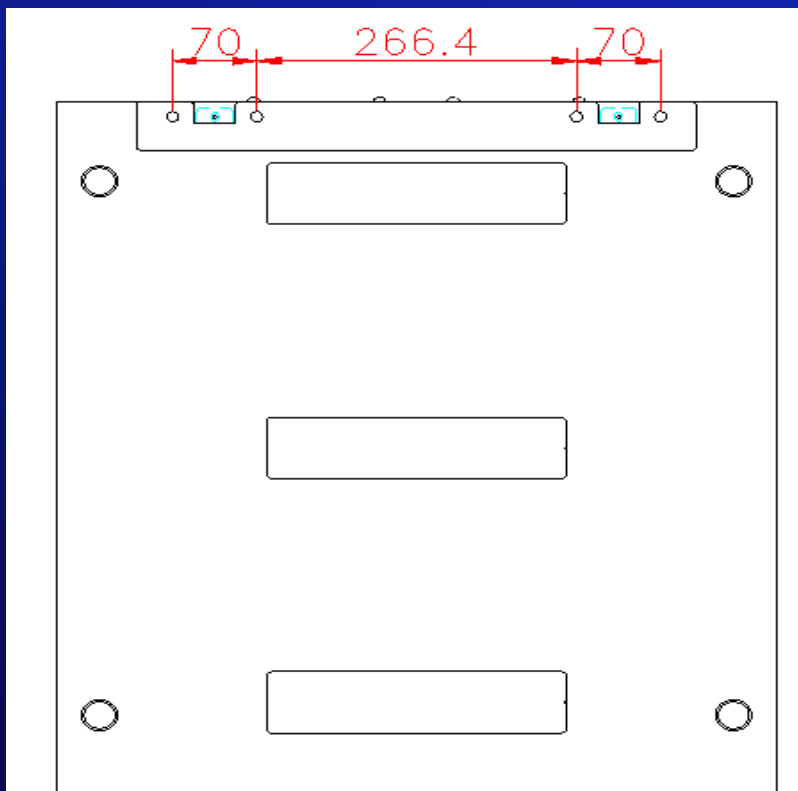

背面 *New Model: Back*

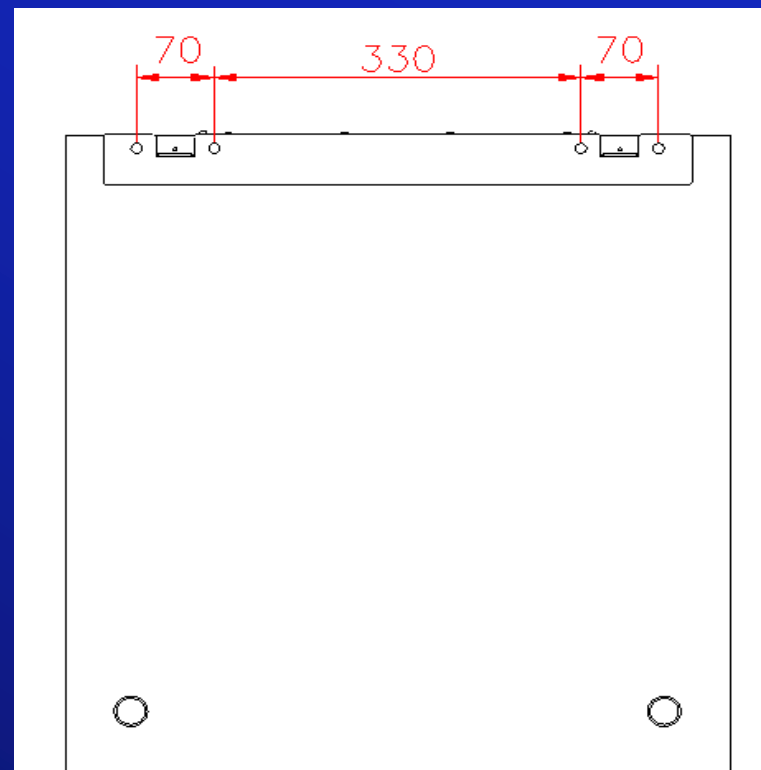

背面 *Old Model: Back*